

Varenummer: 209925V30M8

Beskrivelse: E+G Gevind indsats - GN 992.5-V30-M8

Mål

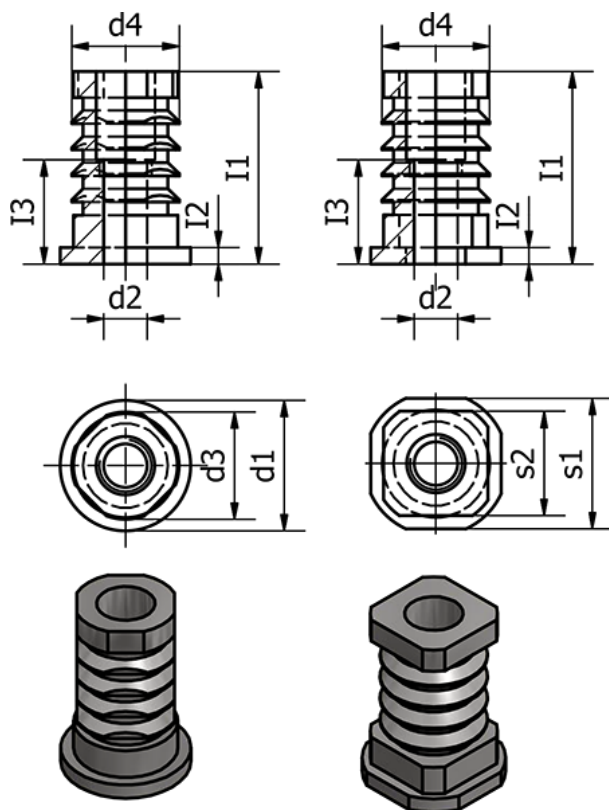

d1 =	s2 = 26
d2 = M8	Vægt (g) = 106
d3 =	
d4 = 26.5	
I1 = 29.5	
I2 = 2.5	
I3 = 18	
s1 = 30	